

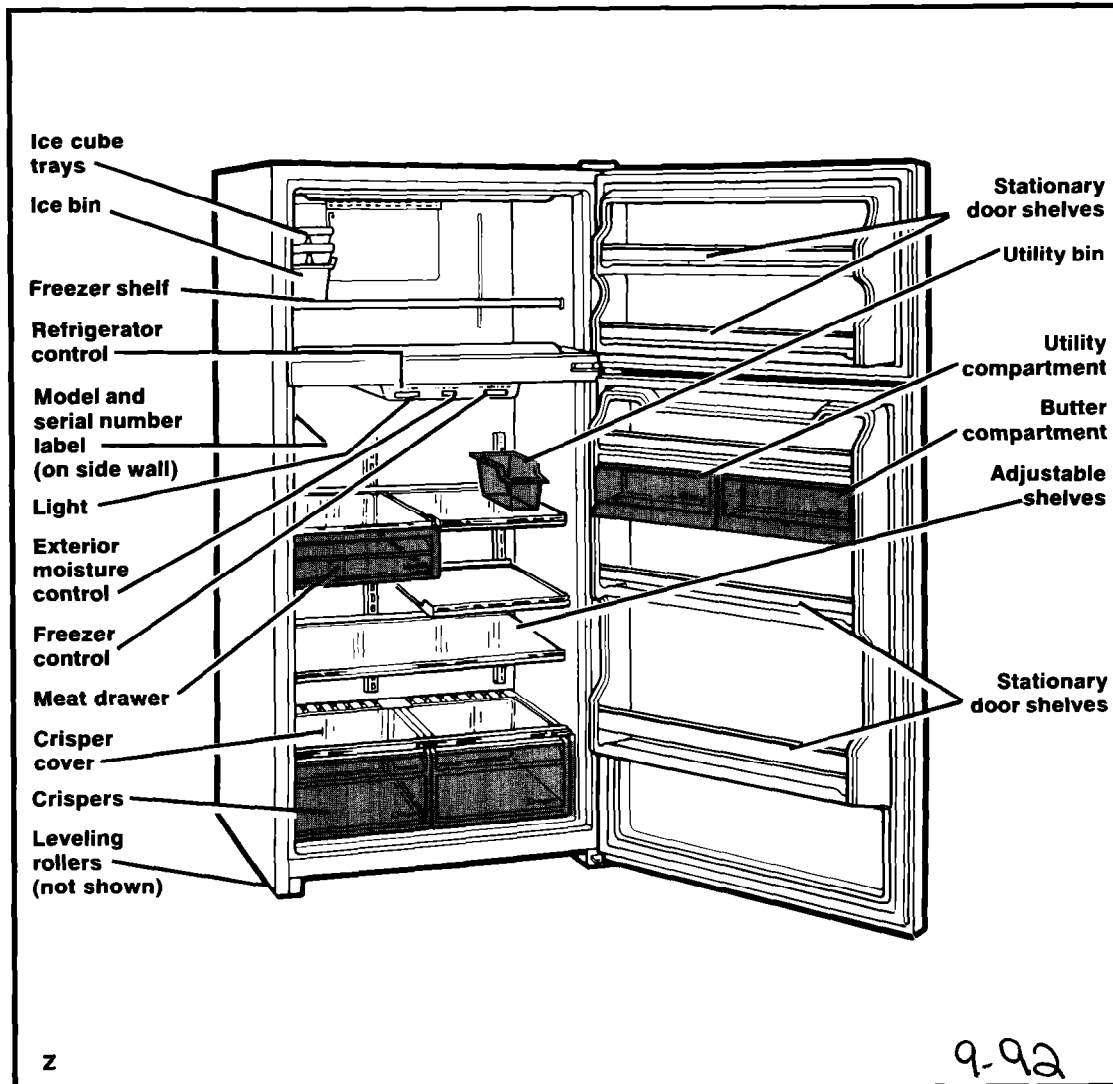

# Use & Care Guide



**NO-FROST REFRIGERATOR-FREEZER  
3ET18GK**

# Contents

	Page
<b>Important Safety Instructions</b> .....	3
<b>Before Using Your Refrigerator</b> .....	4
<b>Using Your Refrigerator</b> .....	5
Setting the controls .....	5
Exterior moisture control .....	6
Adjusting the refrigerator shelves .....	6
Removing the freezer shelf .....	6
Moving the meat drawer and cover .....	6
Removing the crispers .....	7
Removing the crisper cover .....	7
Changing the light bulbs .....	8
Reversing the door swing .....	8
Ice cube trays .....	8
Optional automatic ice maker .....	8
Sounds you may hear .....	9
Energy saving tips .....	9
<b>Cleaning Your Refrigerator</b> .....	10
<b>Food Storage Guide</b> .....	11
Storing fresh food .....	11
Storing frozen food .....	11
<b>Caring For Your Refrigerator</b> .....	13
Vacation and moving care .....	13
Power interruptions .....	13
<b>If You Need Service Or Assistance</b> .....	14
<b>Whirlpool Refrigerator Warranty</b> .....	16

©1991 Whirlpool Corporation

**Thank you for buying a Whirlpool appliance. Please complete and mail the Owner Registration Card provided with this product.**

Then complete the form below. Have this information ready if you need service or call with a question.

- Copy model and serial numbers from label (see diagram on front cover) and purchase date from sales slip.
- Keep this book and sales slip together in a handy place.

---

Model Number

---

Serial Number

---

Purchase Date

---

Service Company Phone Number

Remove the consumer Buy Guide Label, tape and any inside labels (except the model and serial number label) before using refrigerator.

**To remove any remaining glue:**

- Rub briskly with thumb to make a ball, then remove.

**OR**

- Soak area with liquid hand dishwashing detergent before removing glue as described above. Do not use sharp instruments, rubbing alcohol, flammable fluids or abrasive cleaners. These can damage the material. See "Important Safety Instructions" on page 3.

**NOTE:** Do not remove any permanent instruction labels inside your refrigerator. Do not remove the Tech Sheet fastened under the refrigerator at the front.

# Important Safety Instructions

**IMPORTANT SAFETY INSTRUCTIONS**

## **⚠ WARNING**

To reduce the risk of fire, electrical shock, or injury when using your refrigerator, follow basic precautions including the following:

- Read all instructions before using the refrigerator.
- Child entrapment and suffocation are not problems of the past. Junked or abandoned refrigerators are still dangerous...even if they will "just sit in the garage a few days."  
If you are getting rid of your old refrigerator, do it safely. Please read the enclosed safety booklet from the Association of Home Appliance Manufacturers. Help prevent accidents.
- Never allow children to operate, play with, or crawl inside the refrigerator.
- Never clean refrigerator parts with flammable fluids. The fumes can create a fire hazard or explosion.

**• FOR YOUR SAFETY •**

**DO NOT STORE OR USE GASOLINE OR OTHER FLAMMABLE VAPORS AND LIQUIDS IN THE VICINITY OF THIS OR ANY OTHER APPLIANCE. THE FUMES CAN CREATE A FIRE HAZARD OR EXPLOSION.**

### **It is your responsibility to be sure your refrigerator:**

- is installed and leveled on a floor that will hold the weight, and in an area suitable for its size and use.
- is connected only to the proper kind of outlet, with the correct electrical supply and grounding. (Refer to the Electrical Requirements and Grounding Instructions Sheet.)
- is used only to do what home refrigerators are designed to do.
- is not near an oven, radiator or other heat source.
- is properly maintained.
- is out of the weather.
- is used in an area where the room temperature will not fall below 55°F (13°C).
- is not used by anyone unable to operate it properly.
- is not loaded with food before it has time to get properly cold.

**– SAVE THESE INSTRUCTIONS –**

# Before Using Your Refrigerator

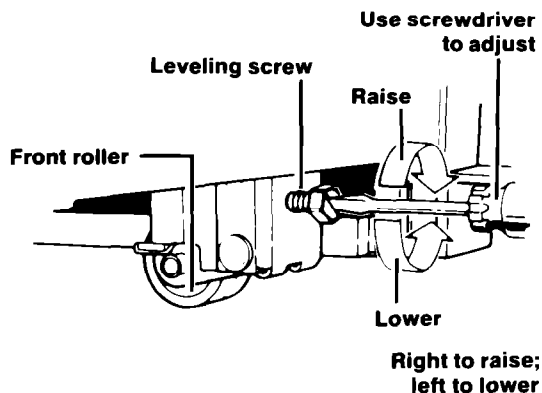
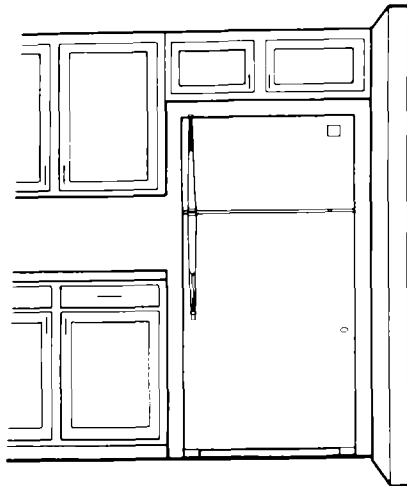
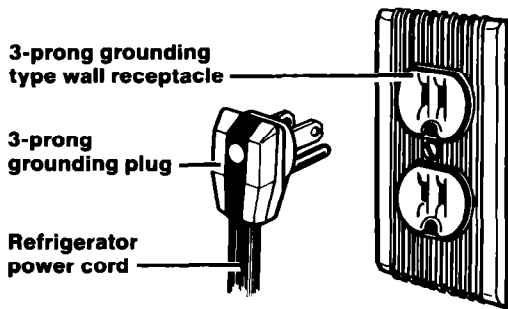

## Clean It

Clean your refrigerator before using it. See cleaning instructions on page 10.

## Plug it in

### Recommended Grounding Method

A 115 Volt, 60 Hz., AC only 15 or 20 ampere fused and properly grounded electrical supply is required. It is recommended that a separate circuit serving only this appliance be provided. Use a receptacle which cannot be turned off with a switch or pull chain. Do not use an extension cord.

See Electrical Requirements and Grounding Instructions Sheet in your Literature Package.

220-230 V/50 HZ  
ADAPTED TO  
115 V/60 HZ  
BY TRANSFORMER  
Part No. 1129492

## Install properly

1. Allow 3 inches (7.5 cm) between overhead cabinets and refrigerator top.
2. Allow at least an inch (2.5 cm) between the refrigerator condenser on the back and the wall.
3. Allow 1/2 inch (1.25 cm) on each side of the refrigerator for ease of installation.
4. If the refrigerator is to be against a wall, you might want to leave extra space on the hinge side so the door can be opened wider.
5. If your refrigerator has an ice maker, make sure ice maker water supply has been connected. Refer to Installation Instructions.

## Level refrigerator-freezer

1. To raise front, turn screw in direction shown.
2. To lower front, turn screw in direction shown.
3. Check with level.

# Using Your Refrigerator

## Setting the controls

Controls for the refrigerator and freezer are in the refrigerator. When the refrigerator is plugged in for the first time:

1. Set the Refrigerator Control to 3.

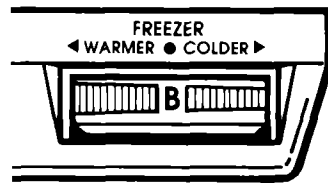
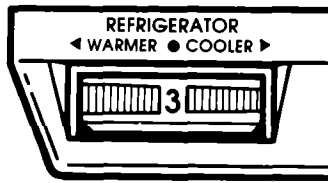

2. Set the Freezer Control to B.

Give the refrigerator time to cool down completely before adding food. (This may take several hours.)

These settings should be about right for normal household refrigerator usage.

The controls will be set about right when milk or juice is as cold as you like and when ice cream is firm.

If you need to adjust temperatures in refrigerator or freezer, use the settings listed in the chart below.

CONDITION:	REASON:	RECOMMENDED CONTROL SETTINGS:
If Refrigerator Section is TOO WARM	Door opened often Large amount of food added Room temperature too warm	Refrigerator 4 Freezer C
If Freezer Section is TOO WARM	Door opened often Large amount of food added Very cold room temperature (can't cycle often enough)	Refrigerator 3 Freezer A
If Refrigerator Section is TOO COLD	Controls not set correctly for your conditions	Refrigerator 2 Freezer B
If ICE isn't MADE FAST ENOUGH	Heavy ice usage Very cold room temperature (can't cycle often enough)	Refrigerator 3 Freezer A
If BOTH SECTIONS are TOO WARM	Door opened often Large amount of food added Very warm or very cold room temperatures	Refrigerator 4 Freezer B

BEFORE USING YOUR REFRIGERATOR • USING YOUR REFRIGERATOR

## Using Your Refrigerator Continued

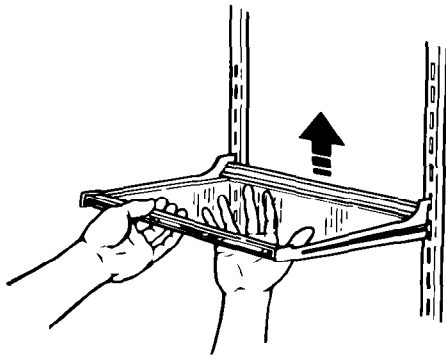
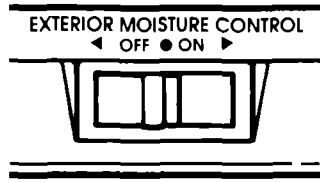

**Glass shelves are heavy. Be careful.**

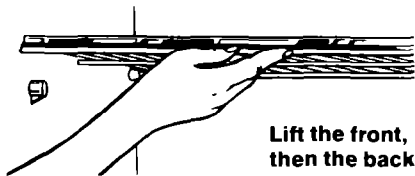

**Lift the front, then the back.**

**Pull out to the stop, lift the front and pull again.**

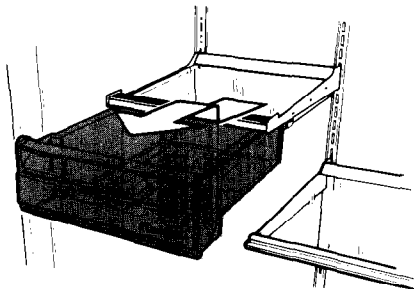

### Exterior Moisture Control

The Exterior Moisture Control on the Control Console operates electric heaters around the door openings. These heaters help keep moisture from forming on the outside of the refrigerator.

1. Use the OFF setting when humidity is low.
2. Use the ON setting if moisture forms on the outside of the refrigerator.

### Adjusting the refrigerator shelves

Shelves can be adjusted to match the way you use your refrigerator. Glass shelves are strong enough to hold bottles, milk and other heavy food items.

#### To remove shelves:

1. Remove items from shelf.
2. Tilt up at front.
3. Lift up at back.
4. Pull shelf straight out.

#### To replace shelves:

1. Guide the rear hooks into the slots in the shelf supports.
2. Tilt up front of shelf until hooks drop into slot. Lower front of shelf to level position.

### Removing the freezer shelf

#### To remove shelf:

1. Lift front slightly.
2. Lift back off supports.
3. Replace in reverse order.

### Moving the meat drawer and cover

#### To remove the meat drawer:

1. Slide the meat drawer out to the stop.
2. Lift the front.
3. Slide the drawer the rest of the way out.
4. Replace in reverse order.

#### To remove the cover:

1. Tilt front of cover up, lift at back, and pull straight out.
2. Replace in reverse order.

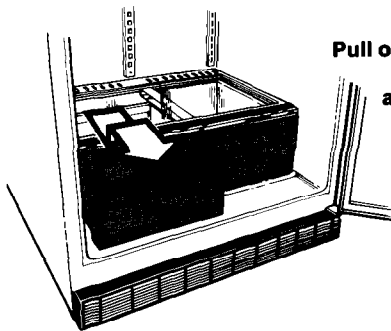

**Pull out to the stop, lift the front and pull again.**

**Removing the crispers**

**To remove the crispers:**

1. Slide crisper straight out to the stop, lift front, then slide out the rest of the way.
2. Replace in reverse order.

**Remove the glass insert, lift the frame front, then the back.**

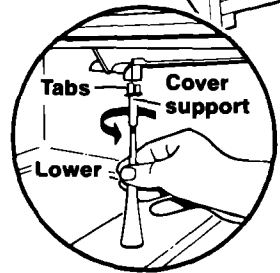
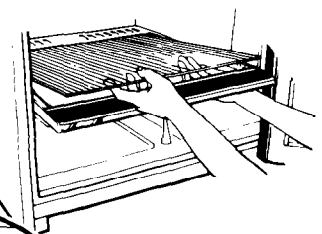

**Removing the crisper cover**

**To remove crisper cover:**

1. Push up glass insert from the bottom, then slide out with both hands.
2. Lift front of cover frame and remove cover support.
3. Lift out cover frame by pulling up and out.

**To replace crisper cover:**

1. Fit back of cover into notch supports on walls of refrigerator, then lower front into place.
2. Insert cover support (with the long tab toward the front) into the groove on the underside of the crisper cover.

**NOTE:** If support needs adjustment, turn base clockwise to raise, or counter-clockwise to lower.

3. Slide back of glass insert into place, then lower front.

## Using Your Refrigerator Continued

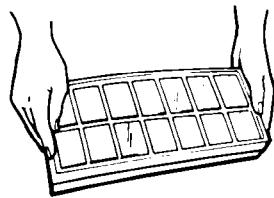
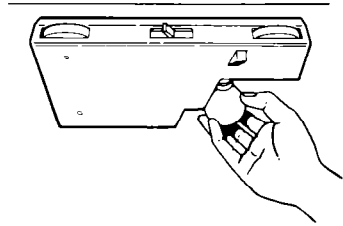

Raise  
signal  
arm to  
stop ice.

Lower  
signal  
arm to  
start it.

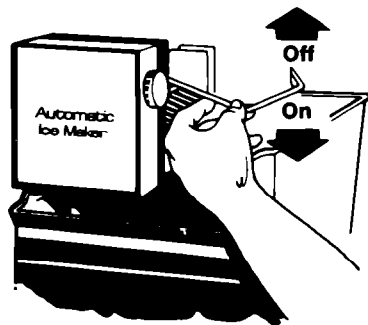

## Changing the light bulbs

### **⚠ WARNING**

#### **Electrical Shock Hazard**

**Before removing a light bulb, either unplug the refrigerator or disconnect the electricity leading to the refrigerator at the main power supply. Shock and injury can occur if electricity remains connected.**

#### **To change refrigerator light:**

1. Disconnect refrigerator from power supply.
2. Reach behind the Control Console to find bulb(s).
3. Remove bulb.
4. Replace with a 40-watt appliance bulb.
5. Reconnect power supply.

**NOTE:** Not all commercial appliance bulbs will fit your refrigerator. Be sure to replace bulb with one of the same size and shape.

#### **Reversing the door swing**

You can change the hinges on your refrigerator so the doors open the other way. Refer to the instructions sheet included with your refrigerator.

#### **Ice cube trays**

If cubes are not used, they may shrink. The moving cold air starts a slow evaporation. The longer cubes are stored, the smaller they get.

#### **To remove ice:**

1. Hold tray at both ends.
2. Twist slightly.

#### **Optional automatic ice maker**

If you have the automatic ice maker accessory, or if you plan to add one later (Part No. ECKMF-90), there are a few things you will want to know:

- The ON/OFF lever is a wire signal arm.  
Down...for making ice automatically.  
Up...to shut off the ice maker.

**NOTE:** Do not turn ice maker on until it is connected to the water supply. **Instructions for ice maker water supply hook-up are attached to the back of the refrigerator cabinet.**

- The dial or lever on the side of the ice maker changes the size of the cubes.
- Shake the bin occasionally to keep cubes separated and to obtain increased storage capacity.
- It is normal for ice crescents to be attached by a corner. They will break apart easily.



- You will hear water running when ice maker is working. You'll hear ice falling into the bin. Don't let these sounds bother you.
- The ice maker will not operate until the freezer is cold enough to make ice. This can take overnight.
- Because of new plumbing connections, the first ice may be discolored or off-flavored. Discard the first few batches of ice.
- If ice is not being made fast enough and more ice is needed, turn the Refrigerator Control toward a higher number. Wait a day and, if necessary, turn the Freezer Control toward A.
- If you remove the ice bin, raise the signal arm to shut off the ice maker. When you return the bin, push it all the way in and lower the arm to the ON position.
- If cubes are stored too long, they may develop an off-flavor...like stale water. Throw them away. Ice maker will make new ice. Cubes in the ice bin can also become smaller by evaporation.
- Good water quality is important for good ice quality. It is not recommended that the ice maker be connected to a softened water supply. Water softener chemicals such as salt from a malfunctioning softener can damage the ice maker mold and lead to poor quality ice. If a softened water supply cannot be avoided, then it is important that the water softener be well maintained and operating properly.

**Sounds you may hear**

Your new refrigerator may make sounds that your old one didn't. Because the sounds are new to you, you might be concerned about them. Don't be. Most of the new sounds are normal. Hard surfaces like the floor, walls and cabinets can make the sounds seem louder.

The following describes the kinds of sounds that might be new to you, and what may be making them.

**Slight hum, soft hiss:**

You may hear the refrigerator's fan motor and moving air.

**Clicking or snapping sounds:**

The thermostat makes a definite click when the refrigerator stops running. It also makes a sound when the refrigerator starts. The defrost timer will click when the defrost cycle starts.

**Water sounds:**

When the refrigerator stops running, you may hear gurgling in the tubing for a few minutes after it stops. You may also hear defrost water running into the defrost water pan.

**Ice maker sounds:**

- **trickling water**
- **thud (clatter of ice)**

If your refrigerator has an ice maker, you may hear buzzing (from the water valve), trickling water and the clatter of ice dumped into the bin.

**Running sounds:**

Your refrigerator has a high-efficiency compressor and motor. It will run longer than older designs. It may even seem to run most of the time.

**Energy saving tips**

You can help your refrigerator use less electricity.

- Check door gaskets for a tight seal. Level the cabinet to be sure of a good seal.
- Clean the condenser coils regularly.
- Open the door as few times as possible. Think about what you need before you open the door. Get everything out at one time. Keep food organized so you won't have to search for what you want. Close door as soon as food is removed.
- Go ahead and fill up the refrigerator, but don't overcrowd it so air movement is blocked.
- It is a waste of electricity to set the refrigerator and freezer to temperatures colder than they need to be. If ice cream is firm in the freezer and drinks are as cold as your family likes them, that's cold enough.
- Keep the Exterior Moisture Control on the OFF setting unless moisture forms on refrigerator exterior.
- Make sure your refrigerator is not next to a heat source such as a range, water heater, furnace, radiator or in direct sunlight.

# Cleaning Your Refrigerator

Both the refrigerator and freezer sections defrost automatically. But both should be cleaned about once a month to help prevent odors from building up. Spills should be wiped up right away.

To clean your refrigerator, turn the Refrigerator Control to OFF, unplug it, take out all removable parts and clean it according to the following directions.

<b>PART</b>	<b>WHAT TO USE</b>	<b>HOW TO CLEAN</b>
<b>Removable parts</b> (shelves, crisper, meat drawer, etc.)	<ul style="list-style-type: none"> <li>• Sponge or cloth</li> <li>• Mild detergent</li> <li>• Warm water</li> </ul>	<ul style="list-style-type: none"> <li>• Wash.</li> <li>• Rinse and dry thoroughly.</li> </ul>
<b>Outside</b>	<ul style="list-style-type: none"> <li>• Sponge, cloth or paper towel</li> <li>• Mild detergent</li> <li>• Warm water</li> <li>• Appliance wax (or good auto paste wax)</li> </ul>	<ul style="list-style-type: none"> <li>• Wash outside of cabinet. <b>Do not use abrasive or harsh cleaners.</b></li> <li>• Rinse and dry thoroughly.</li> <li>• Wax painted metal surfaces at least twice a year. Apply wax with a clean, soft cloth.</li> </ul> <p><b>Waxing painted metal surfaces provides rust protection. Do not wax plastic parts.</b></p>
<b>Inside walls</b> (freezer should be allowed to warm up so cloth won't stick)	<ul style="list-style-type: none"> <li>• Sponge, soft cloth or paper towel</li> <li>• Baking soda or mild detergent</li> <li>• Warm water</li> </ul>	<ul style="list-style-type: none"> <li>• Wash with a mixture of warm water and               <ul style="list-style-type: none"> <li>– mild detergent, or</li> <li>– baking soda (2 tablespoons [26 g] to 1 quart [.95 L] of water)</li> </ul> </li> <li>• Rinse and dry thoroughly.</li> </ul>
<b>Door liners and gaskets</b>	<ul style="list-style-type: none"> <li>• Sponge, soft cloth or paper towel</li> <li>• Mild detergent</li> <li>• Warm water</li> </ul>	<ul style="list-style-type: none"> <li>• Wash.</li> <li>• Rinse and dry thoroughly.</li> </ul> <p><b>DO NOT USE cleaning waxes, concentrated detergents, bleaches or cleaners containing petroleum on plastic parts.</b></p>
<b>Plastic parts</b> (covers and panels)	<ul style="list-style-type: none"> <li>• Soft, clean sponge or soft, clean cloth</li> <li>• Mild detergent</li> <li>• Warm water</li> </ul>	<ul style="list-style-type: none"> <li>• Wash.</li> <li>• Rinse and dry thoroughly.</li> </ul> <p><b>DO NOT USE paper towels, window sprays, scouring cleansers or flammable fluids. These can scratch or damage material. See "Important Safety Instructions" on page 3.</b></p>
<b>Defrost pan</b> (behind refrigerator on top of the motor)	<ul style="list-style-type: none"> <li>• Sponge or cloth</li> <li>• Mild detergent</li> <li>• Warm water</li> </ul>	<ul style="list-style-type: none"> <li>• Roll refrigerator out away from the wall.</li> <li>• Wash defrost pan. <b>Do not remove defrost pan to clean.</b></li> <li>• Rinse and dry thoroughly.</li> <li>• Roll refrigerator back into place.</li> <li>• Check to see if refrigerator is level.</li> </ul>
<b>Condenser coils</b>	<ul style="list-style-type: none"> <li>• Vacuum cleaner with extended narrow attachment</li> </ul>	<ul style="list-style-type: none"> <li>• Roll refrigerator out away from the wall.</li> <li>• Vacuum coils at least once every other month.</li> <li>• Roll refrigerator back into place. Leave 1 inch (2.5 cm) between wall and condenser coils on back of refrigerator.</li> <li>• Check to see if the refrigerator is level.</li> </ul>
<b>Floor under refrigerator</b>	<ul style="list-style-type: none"> <li>• Floor cleaners</li> </ul>	<ul style="list-style-type: none"> <li>• Roll refrigerator out away from the wall.</li> <li>• Clean floor.</li> <li>• Roll refrigerator back into place.</li> <li>• Check to see if the refrigerator is level.</li> </ul>

# Food Storage Guide

There is a correct way to package and store refrigerated or frozen food. To keep food fresher, longer, take the time to study these recommended steps.

## Storing fresh food

Food placed in the refrigerator should be wrapped or stored in air and moisture proof material. This prevents food odor and taste transfer throughout the refrigerator. For dated products, check code date to ensure freshness.

### Leafy vegetables

Remove store wrapping and trim or tear off bruised and discolored areas. Wash in cold water and drain. Place in plastic bag or plastic container and store in crisper.

### Vegetables with skins (carrots, peppers)

Store in crisper, plastic bags or plastic container.

### Fruit

Wash, let dry and store in refrigerator in plastic bags or crisper. Do not wash or hull berries until they are ready to use. Sort and keep berries in their store container in a crisper, or store in a loosely closed paper bag on a refrigerator shelf.

### Meat

Most meat can be stored in original wrapping as long as it is air and moisture proof. Rewrap if necessary. See the following chart for storage times.

#### Storage chart for fresh and cured meat\*

TYPE	APPROXIMATE TIME (DAYS)
Chicken . . . . .	1 to 2
Ground beef . . . . .	1 to 2
Steaks and roasts . . . . .	3 to 5
Cured meats . . . . .	7 to 10
Bacon . . . . .	5 to 7
Cold cuts . . . . .	3 to 5
Variety meats . . . . .	1 to 2

\*If meat is to be stored longer than the times given, follow the directions for freezing.

**NOTE:** Fresh fish and shellfish should be used the same day as purchased.

### Eggs

Store without washing in the original carton on interior shelf.

### Milk

Wipe milk cartons. For best storage, place milk on interior shelf.

### Butter or margarine

Keep opened butter in covered dish or closed compartment. When storing an extra supply, wrap in freezer packaging and freeze.

### Cheese

Store in the original wrapping until you are ready to use it. Once opened, rewrap tightly in plastic wrap or aluminum foil.

### Leftovers

Cover leftovers with plastic wrap or aluminum foil. Plastic containers with tight lids can also be used.

## Storing frozen food

The freezer section is designed for storage of commercially frozen food and for freezing food at home. For further information about preparing food for freezing, contact your local Cooperative Extension Service or check a freezer guide or cookbook.

### Packaging

The secret of successful freezing is in the packaging. The way you close and seal the package must not allow air or moisture in or out. Packaging done in any other way could cause food odor and taste transfer throughout the refrigerator and drying of frozen food.

Rigid polyethylene (plastic) containers with tight fitting lids, straight-sided canning/freezing jars, heavy-duty aluminum foil, plastic-coated paper and nonpermeable plastic wraps (made from a saran film) are recommended. Follow package or container instructions for proper freezing methods.

### Do not use:

- Bread wrappers
- Non-polyethylene plastic containers
- Containers without tight lids
- Waxed paper
- Waxed-coated freezer wrap
- Thin, semi-permeable wrap

The use of these wrappings could cause food odor and taste transfer and drying of frozen food.

### Freezing

Do not expect your freezer to quick-freeze any large quantity of food. Put no more unfrozen food into the freezer than will freeze within 24 hours. (No more than 2 to 3 pounds of food per cubic foot of freezer space.) Leave enough space for air to circulate around packages. Be careful to leave enough room at the front so the door can close tightly.

**Food Storage Guide  
Continued**

**Freezer food storage chart**

Storage times will vary according to the quality of the food, the type of packaging or wrap used (air and moisture proof), and the storage temperature which should be 0°F (-17.8°C).

**FOOD STORAGE TIME**

**Fruits**

- Fruit juice concentrate . . . . . 12 months
- Commercially frozen fruit . . . . . 12 months
- Citrus fruit and juices . . . . . 4 to 6 months
- Others . . . . . 8 to 12 months

**Vegetables**

- Commercially frozen . . . . . 8 months
- Home frozen . . . . . 8 to 12 months

**Meat**

- Bacon . . . . . 4 weeks or less
- Corned beef . . . . . 4 weeks or less  
(Salting meat shortens freezer life)
- Frankfurters . . . . . 1 month
- Ground beef, lamb, veal . . . . . 2 to 3 months
- Roasts:
  - Beef . . . . . 6 to 12 months
  - Lamb and veal . . . . . 6 to 9 months
  - Pork . . . . . 4 to 8 months
- Sausage, fresh . . . . . 1 to 2 months
- Steaks and chops:
  - Beef . . . . . 8 to 12 months
  - Lamb, veal, pork . . . . . 3 to 4 months

**Fish**

- Cod, flounder, haddock, sole . . . . . 6 months
- Blue fish, salmon . . . . . 2 to 3 months
- Mackerel, perch . . . . . 2 to 3 months
- Breaded fish (purchased) . . . . . 3 months
- Clams, oysters, cooked
  - fish, crab, scallops . . . . . 3 to 4 months
- Alaskan king crab . . . . . 10 months
- Shrimp, uncooked . . . . . 12 months

**Poultry**

- Chicken or turkey,
  - whole or parts . . . . . 12 months
- Duck . . . . . 6 months
- Giblets . . . . . 2 to 3 months
- Cooked poultry w/gravy . . . . . 6 months
- Slices (no gravy) . . . . . 1 month

**FOOD STORAGE TIME**

**Main dishes**

- Stews; meat, poultry  
and fish casserole . . . . . 2 to 3 months
- TV dinners . . . . . 3 to 6 months

**Dairy products**

- Butter . . . . . 6 to 9 months
- Margarine . . . . . 12 months
- Cheese:
  - Camembert, Mozzarella,  
Farmer's . . . . . 3 months
  - Creamed cottage . . . . . DO NOT FREEZE
  - Cheddar, Edam, Gouda,  
Swiss, Brick, etc. . . . . 6 to 8 weeks  
(Freezing can change texture of cheese.)
  - Ice cream, ice milk, sherbet . . . . . 2 months

**Eggs**

- Whole (mixed) . . . . . 12 months
- Whites . . . . . 12 months
- Yolks . . . . . 12 months  
(Add sugar or salt to yolks or whole mixed eggs)

**Baked goods**

- Yeast breads and rolls . . . . . 3 months
- Baked Brown 'N Serve rolls . . . . . 3 months
- Unbaked breads . . . . . 1 month
- Quick breads . . . . . 2 to 3 months
- Cakes, unfrosted . . . . . 2 to 4 months
- Cakes, frosted . . . . . 8 to 12 months
- Fruit cakes . . . . . 12 months
- Cookie dough . . . . . 3 months
- Baked cookies . . . . . 8 to 12 months
- Baked pies . . . . . 1 to 2 months
- Pie dough only . . . . . 4 to 6 months

Based on U.S.D.A. and Michigan Cooperative Extension Service suggested storage times.

# Caring For Your Refrigerator

## Vacation and moving care

### Short vacations

No need to shut off the refrigerator if you will be away for less than four weeks. Use up perishables; freeze other items. If your refrigerator is equipped with an automatic ice maker:

1. Turn off your ice maker by raising signal arm.
2. Shut off the water supply to the ice maker.
3. Empty the ice bin.

### Long vacations

Remove all the food if you are going for a month or more. If your refrigerator is equipped with an automatic ice maker, turn off the water supply to the ice maker at least a day ahead. When the last load of ice drops, turn off the ice maker.

Unplug the refrigerator and clean it...rinse well and dry. Tape rubber or wood blocks to the top of both doors...keeping them open far enough for air to get in. This will keep odor and mold from building up.

## WARNING

### Personal Injury Hazard

**Do not allow children to climb on, play near or climb inside the refrigerator when the doors are blocked open. They may become injured or trapped.**

To restart refrigerator, see "Using Your Refrigerator" on page 5.

### Moving

If your refrigerator is equipped with an automatic ice maker, shut off the ice maker water supply a day ahead of time. Disconnect the water line. After the last supply of ice drops, lift the signal arm to turn off the ice maker.

Remove all food. Pack frozen food in dry ice. Unplug the refrigerator and clean it thoroughly.

Take out all removable parts. Wrap all parts well and tape them together so they don't shift and rattle.

Screw in the leveling rollers. Tape the doors shut and tape the electric cord to the cabinet.

When you get to your new home, put everything back and refer to page 4. Don't forget to reconnect the water supply line if you have an ice maker.

## Power interruptions

If electricity goes off, call the power company. Ask how long power will be off.

1. If service is to be interrupted 24 hours or less, **keep both doors closed.** This will help frozen food stay frozen.
2. If service is to be interrupted longer than 24 hours:
  - (a) Remove all frozen food and store in a frozen food locker.

### OR

- (b) Place 2 lbs. (0.9 kg) of dry ice in freezer for every cu. ft. of freezer space. This will keep food frozen for 2 to 4 days. Wear gloves to protect your hands from dry ice burns.
  - (c) If neither food locker storage nor dry ice is available, use or can perishable food at once.
3. A full freezer will stay cold longer than a partly filled one. A freezer full of meat will stay cold longer than a freezer full of baked goods. If food contains ice crystals, it may be safely refrozen, although the quality and flavor may be affected. If the condition of the food is poor or if you feel it is unsafe, dispose of it.

# If You Need Service Or Assistance

## We suggest you follow these steps:

### 1. Before calling for assistance...

Performance problems often result from little things you can find and fix yourself without tools of any kind.

#### If your refrigerator will not operate:

- Is the power supply cord plugged into a live circuit with proper voltage? (See page 4.)
- Have you checked your home's main fuses or circuit breaker box?
- Is the Refrigerator Control ON?

#### If there is a rattling or jingling noise or unfamiliar sounds:

- Is something on top of or behind the refrigerator making noise when the refrigerator is running?
- New features on your new refrigerator make new sounds. You may be hearing air flowing from the fans, timer clicks for the defrosting cycle, or defrost water draining in the defrost pan.

#### If your ice maker will not operate:

- Has the freezer had enough time to get cold? With a new refrigerator, this might take overnight.
- Is the signal arm ON... in the down position?
- Is the water valve turned on? Is water getting to the ice maker?

#### If there is water in the defrost pan:

- This is normal in hot, muggy weather. The pan can even be half full. Make sure the refrigerator is level so the pan does not overflow.

#### If the light does not work:

- Have you checked your home's main fuses or circuit breaker box?
- Is the power supply cord plugged into a live circuit with proper voltage? (See page 4.)

#### If a bulb is burned out:

- See instructions for changing light bulbs on page 8. Use appliance bulbs only.

#### If the motor seems to run too much:

- Is the condenser free of dust and lint?
- On hot days, or if the room is warm, the motor naturally runs longer.
- If the door has been opened a lot, or if a large amount of food has been put in, the motor will run longer to cool down the interior.

### Remember:

Motor running time depends on different things: number of door openings, amount of food stored, temperature of the room, setting of the controls.

Your new refrigerator may be larger than your old one so it has more space to be cooled. It also has a regular freezer instead of a frozen food compartment. All this means better refrigeration and may require more running time than your old one.

### 2. If the problem is not due to one of the above items\*..

Contact the dealer from whom you purchased the unit, or an authorized Whirlpool<sup>SM</sup> service company.

### 3. If you need FSP<sup>®</sup> replacement parts\*..

FSP is a registered trademark of Whirlpool Corporation for quality parts. Look for this symbol of quality whenever you need a replacement part for your Whirlpool appliance. FSP replacement parts will fit right and work right, because they are made to the same exacting specifications used to build every new Whirlpool appliance.

To locate FSP replacement parts in your area, contact the dealer from whom you purchased the unit, or an authorized Whirlpool<sup>SM</sup> service company.

\*When requesting assistance, please provide: model number, serial number, date of purchase, and a complete description of the problem. This information is needed in order to better respond to your request.



# WHIRLPOOL® Refrigerator Warranty

RF004

LENGTH OF WARRANTY	WHIRLPOOL WILL PAY FOR
<b>FULL ONE-YEAR WARRANTY</b> From Date of Purchase	FSP® replacement parts and repair labor to correct defects in materials or workmanship. Service must be provided by an authorized Whirlpool <sup>SM</sup> service company.
<b>LIMITED FIVE-YEAR WARRANTY</b> From Date of Purchase	FSP replacement parts for electronic control system if defective in materials or workmanship. (Electronic models only.)
<b>FULL FIVE-YEAR WARRANTY</b> From Date of Purchase	FSP replacement parts and repair labor to correct defects in materials or workmanship in the sealed refrigeration system. These parts are: <ol style="list-style-type: none"> <li>1. Compressor</li> <li>2. Evaporator</li> <li>3. Condenser</li> <li>4. Drier</li> <li>5. Connecting tubing</li> </ol> Service must be provided by an authorized Whirlpool <sup>SM</sup> service company.
<b>WHIRLPOOL WILL NOT PAY FOR</b>	
<p><b>A.</b> Service calls to:</p> <ol style="list-style-type: none"> <li>1. Correct the installation of the refrigerator.</li> <li>2. Instruct you how to use the refrigerator.</li> <li>3. Replace house fuses or correct house wiring or plumbing.</li> <li>4. Replace light bulbs.</li> </ol> <p><b>B.</b> Repairs when refrigerator is used in other than normal, single-family household use.</p> <p><b>C.</b> Pickup and delivery. This product is designed to be repaired in the home.</p> <p><b>D.</b> Damage to refrigerator caused by accident, misuse, fire, flood, acts of God or use of products not approved by Whirlpool.</p> <p><b>E.</b> Any labor costs during limited warranty.</p> <p><b>F.</b> Any food loss due to product failure.</p> <p><b>G.</b> Repairs to parts or systems caused by unauthorized modifications made to the appliance.</p>	

WHIRLPOOL CORPORATION SHALL NOT BE LIABLE FOR INCIDENTAL OR CONSEQUENTIAL DAMAGES.

Outside the United States, a different warranty may apply. For details, please contact your authorized Whirlpool distributor or military exchange.

® Registered Trademark/TM Trademark/SM Service Mark of Whirlpool Corporation